

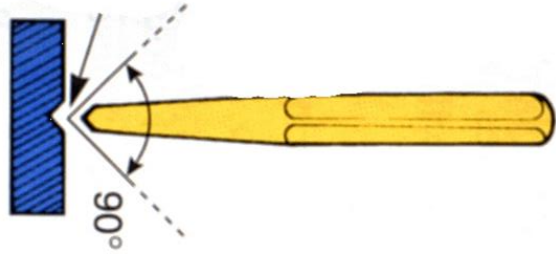



MECHANICS HANDTOOLS

FIRST & LAST NAME: _____

Print the name of the following tools neatly underneath their picture:



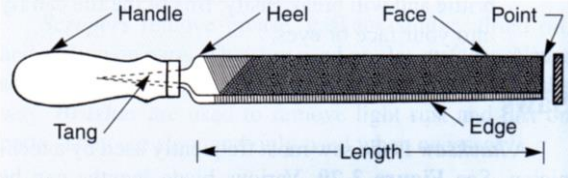
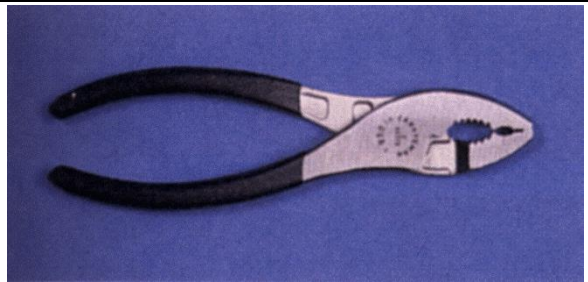
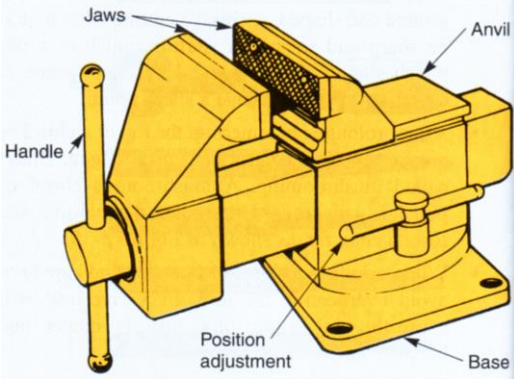

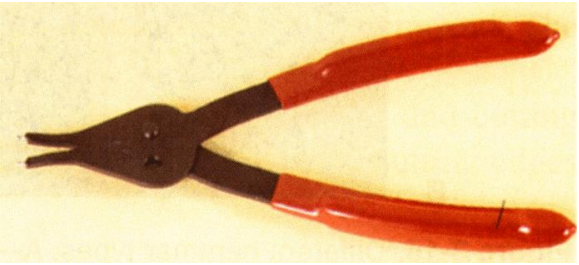
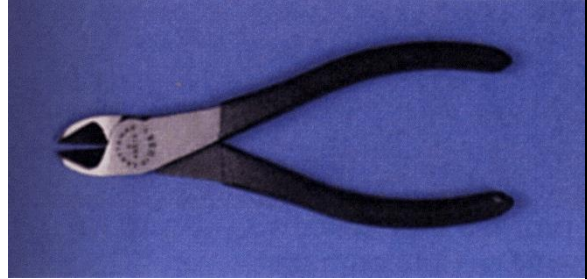
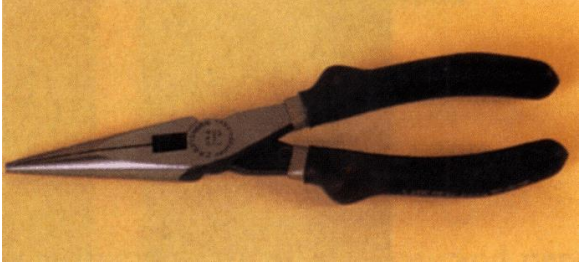

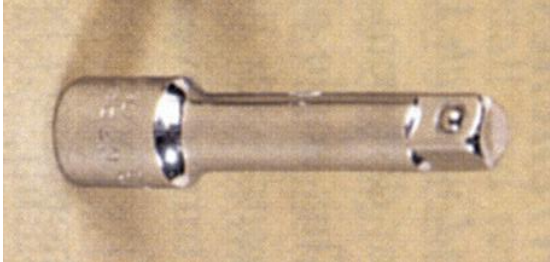
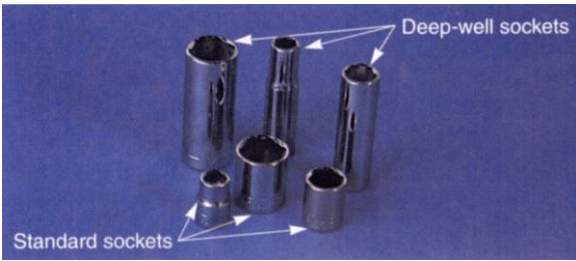





SKETCH or PASTE IMAGE of the tip of the following screwdrivers:

Philips (super common):

Robertson (never used as a factory fastener):

Torx (common):

Clutch (Old vehicles):

When removing a fastener, given a choice, should you PUSH against the wrench, or PULL against the wrench?

Explain why you chose your answer.