

BRACKET

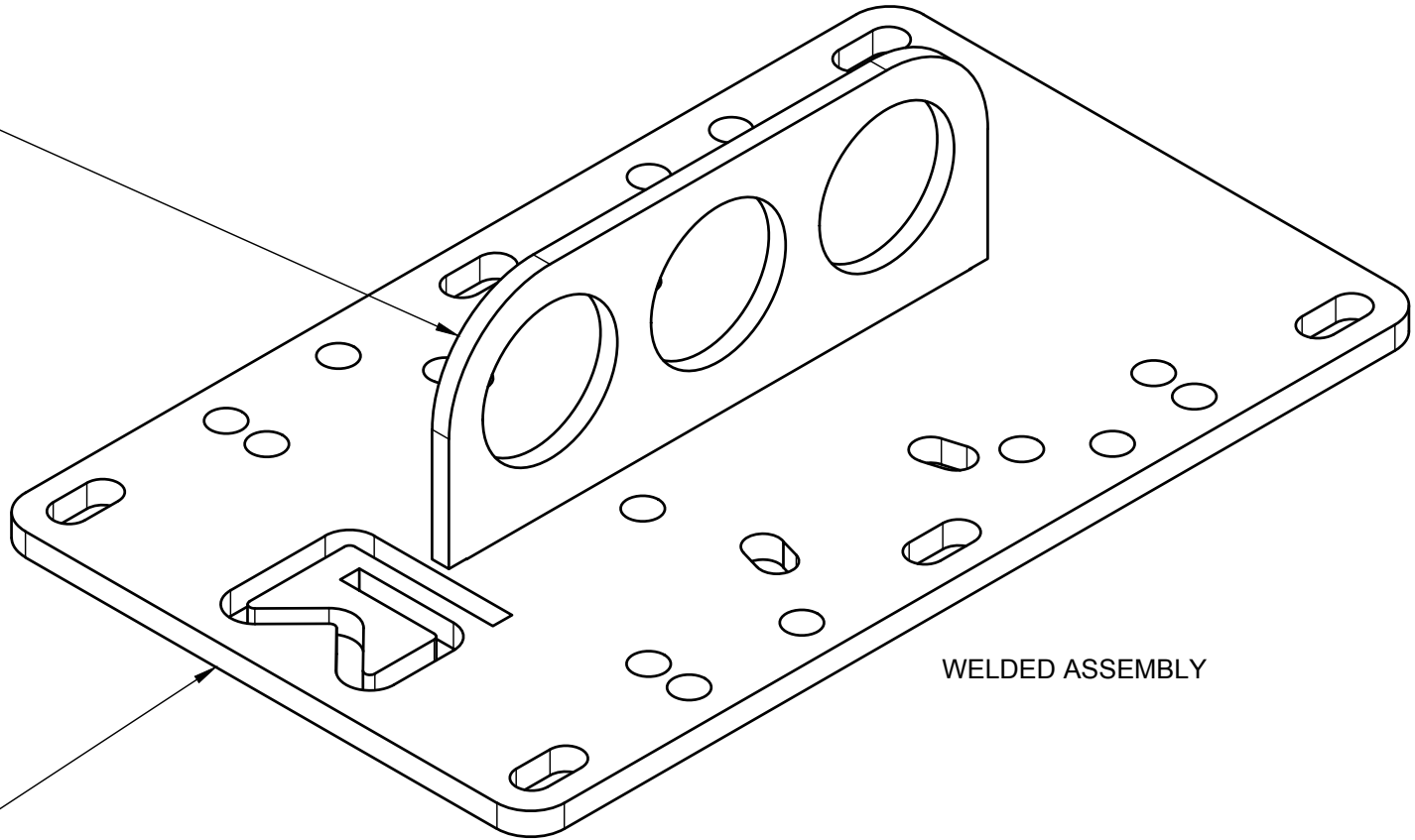

WELDED ASSEMBLY

BASE

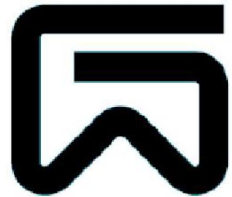

Mr.WELLWOOD'S
SHOP OF HORRORS
www.gwellwood.com

PROJECT

MOTOR LIFT PLATE

TITLE

ASSEMBLY

APPROVED

CHECKED

DRAWN

Greg Wellwood

21/07/01

SIZE

A

CODE

DWG NO

SCALE 1:1.5

WEIGHT

SHEET 1/6

REV

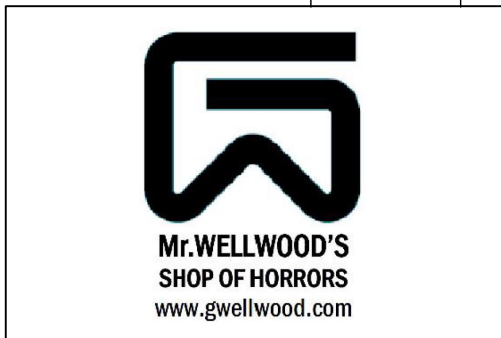
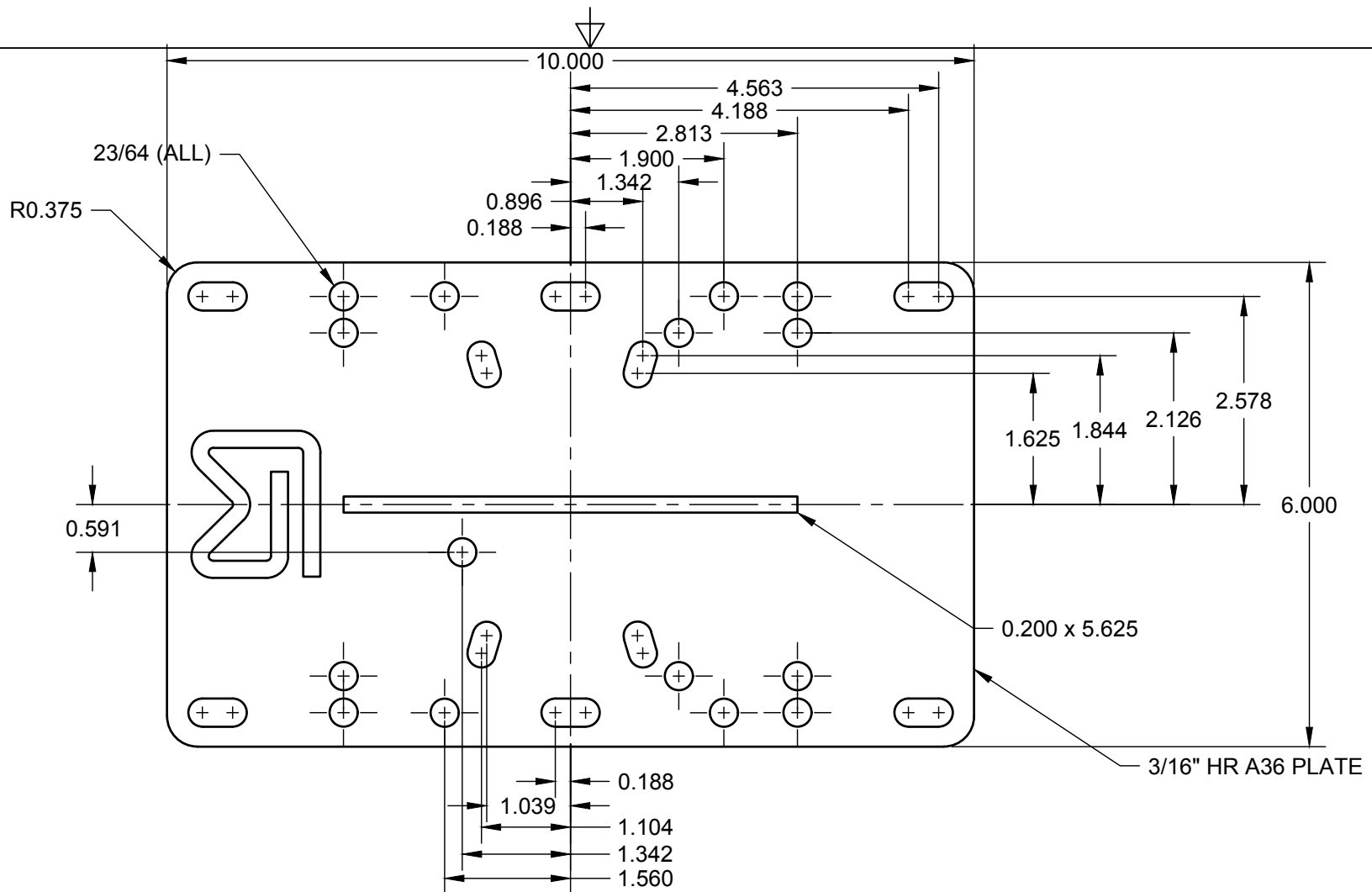

PROJECT
MOTOR LIFT PLATE

TITLE
BASE

APPROVED
 CHECKED
 DRAWN Greg Wellwood 21/07/01

SIZE	CODE	DWG NO	REV
A			
SCALE 1:2		WEIGHT	SHEET 2/6



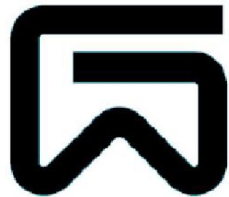
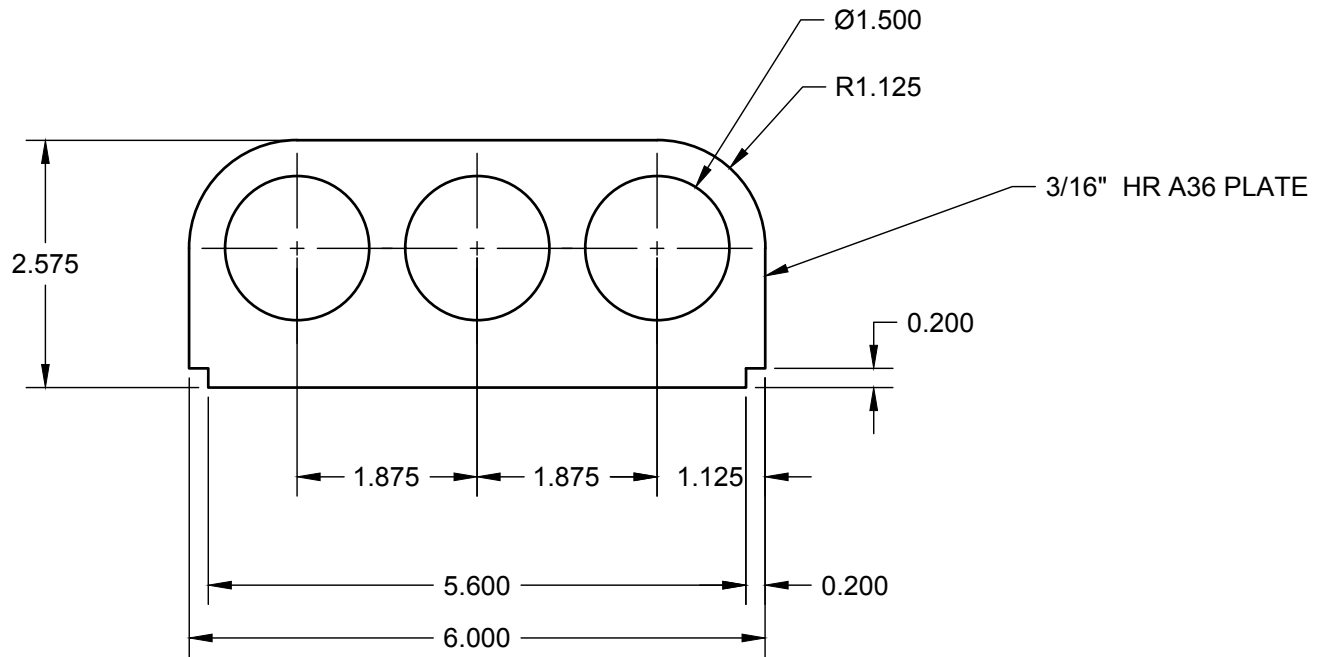

Mr. WELLWOOD'S
SHOP OF HORRORS
www.gwellwood.com

PROJECT

MOTOR LIFT PLATE

TITLE

BRACKET

APPROVED

CHECKED

DRAWN

Greg Wellwood

21/07/01

SIZE

A

CODE

DWG NO

SCALE 1:2

WEIGHT

SHEET 3/6

REV

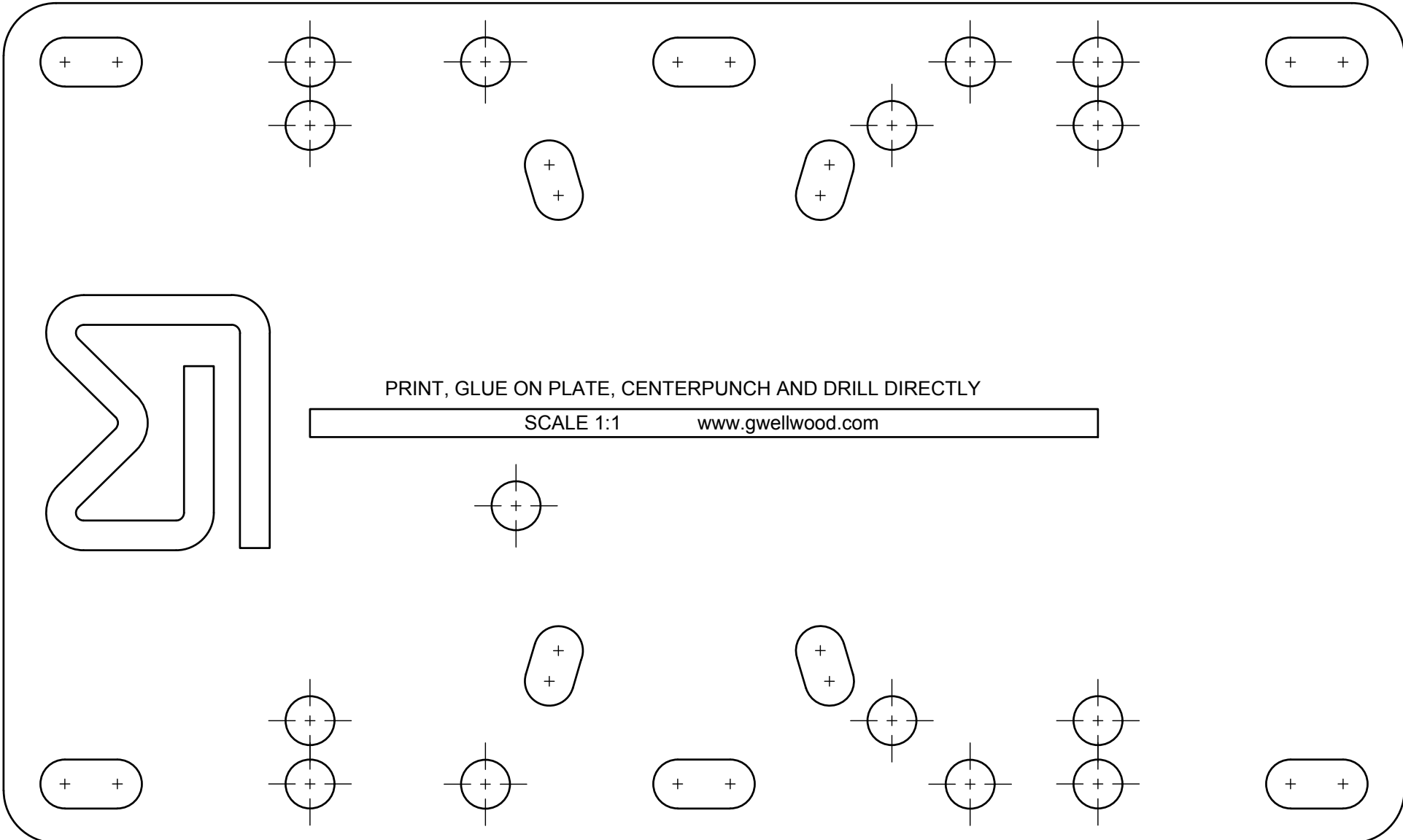

PRINT, GLUE ON PLATE, CENTERPUNCH AND DRILL DIRECTLY

SCALE 1:1 www.gwellwood.com

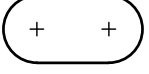
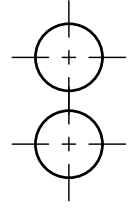
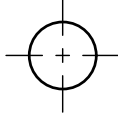
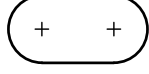
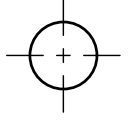
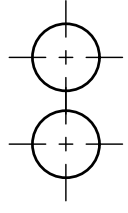
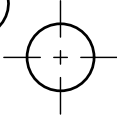
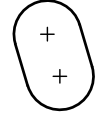
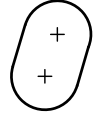
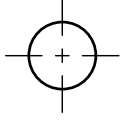
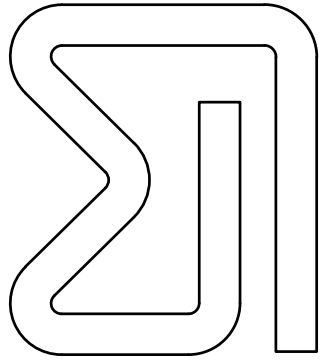
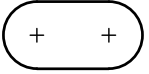
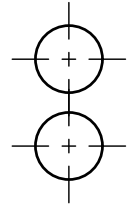
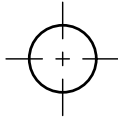
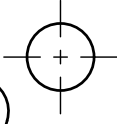
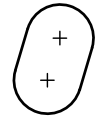
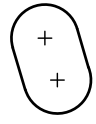
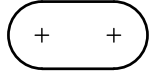
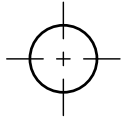
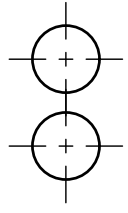
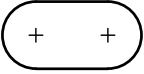

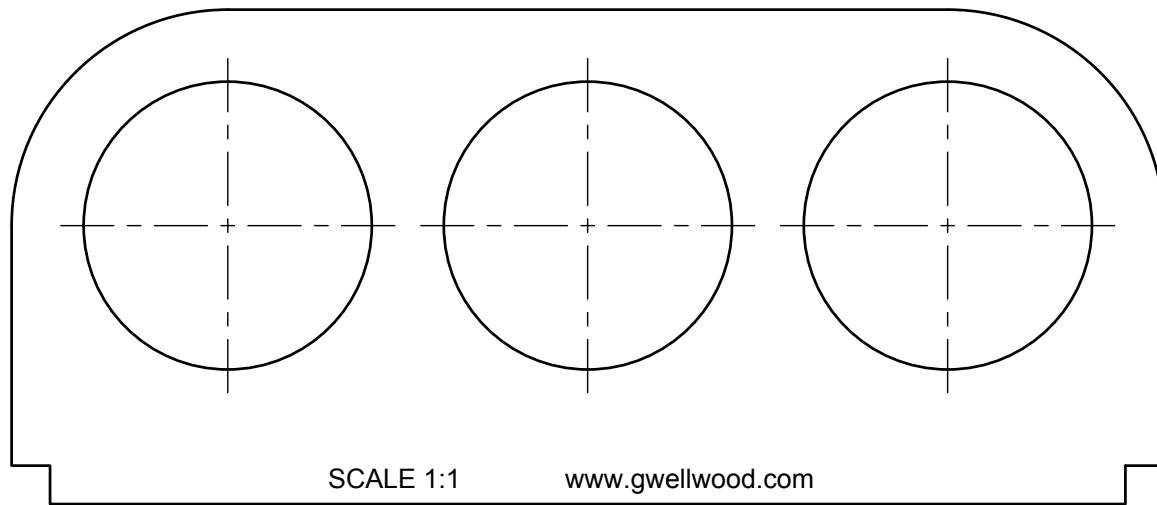

SCALE 1:1

www.gwellwood.com

